



Grayhill, Inc.

**62S11-H9-060SH**

Numero di parti:

62S11-H9-060SH

Manufacturer / Brand:

Grayhill, Inc.

Descrizione di prodotto

ROTARY ENCODER OPTICAL 32PPR

Schede tecniche:

 62S11-H9-060SH.pdf

Status RoHS

 Cumpite senza piombo / RoHS

Nave Da

Hong Kong

Modu di Spedizioni

DHL/Fedex/TNT/UPS/EMS

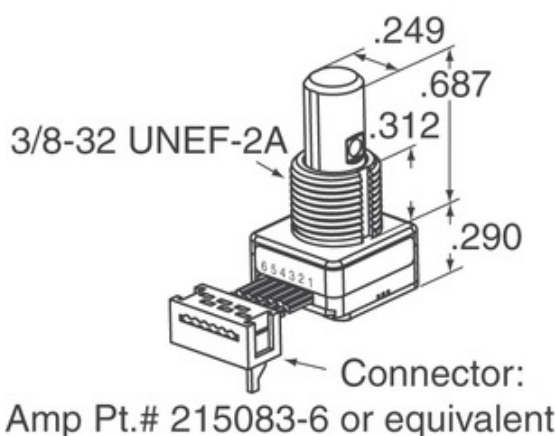
[RICHIESTA DI STIMA](#)

L'imaghjini pò esse ripresentazione. Vede e specificazioni per i dettagli di u produttu.



**Specificazioni di 62S11-H9-060SH**

NUMERO DI PARTI	62S11-H9-060SH
PRODUTTORE	Grayhill, Inc.
DESCRIZIONE	ROTARY ENCODER OPTICAL 32PPR
STATU SENZA PIOMBO / STATUS ROHS	Cumpite senza piombo / RoHS
SCHEDA TECNICA	 62S11-H9-060SH.pdf
VOLTAGE - SUPPLY	5V
STILE DI TERMINAZIONE	Cable Leads
SERIE	62S
VITA DI ROTAZIONE (CICLI MIN)	1M
SPINTA PER REVOLUZIONE	32
TIPU DI USCITA	Quadrature (Incremental)
ALTRI NOMI	62S11H9060SH
ORIENTAZIONE	Vertical
TIPO DI MONTAGGIO	Panel Mount
LIVELLU DI SENSIBILITÀ À L'UMIDITÀ (MSL)	1 (Unlimited)
TEMPU STANDARD DI COSTRUTTORE	8 Weeks
STATU SENZA PIOMBO / STATUS ROHS	Lead free / RoHS Compliant
TIPU ENCODER	Optical
FERMO	Yes
CUMPAGNATU IN SWITCH	Yes
TIPU DI ATTUATORE	1/4" Dia Flatted End

**Tags Tags**

Grayhill, Inc. 62S11-H9-060SH	Distributore 62S11-H9-060SH	Fornitore 62S11-H9-060SH
Prezzo 62S11-H9-060SH	62S11-H9-060SH Pictures	Image 62S11-H9-060SH
Ficha Tecnica 62S11-H9-060SH PDF	62S11-H9-060SH Scaricate a scheda tecnica	Ficha di dati 62S11-H9-060SH
Stock 62S11-H9-060SH	Cumprate 62S11-H9-060SH	Cumprate Grayhill, Inc. 62S11-H9-060SH
Grayhill, Inc. 62S11-H9-060SH	Fornitore Grayhill, Inc.	Distributore Grayhill, Inc.
Grayhill, Inc. 62S11-H9-060SH	Grayhill Inc. 62S11-H9-060SH	

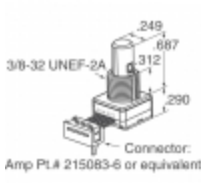
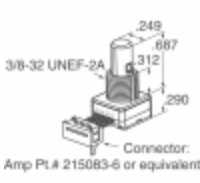
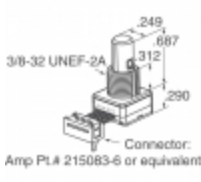
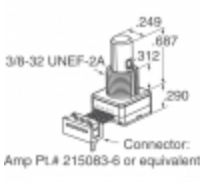
**Prodotti Relatati**

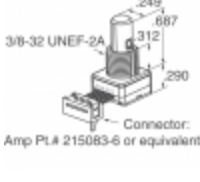
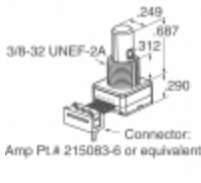
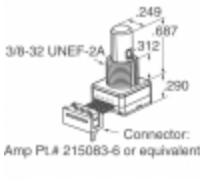
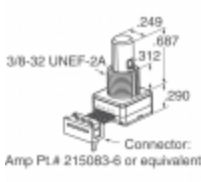
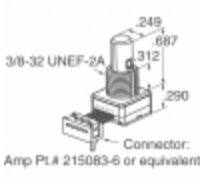
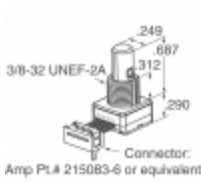
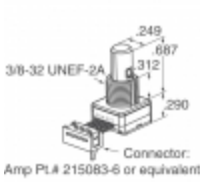
 <p><b>62S11-L0-040C</b>            Produttori: Grayhill, Inc.            Descrizione: ROTARY ENCODER OPTICAL 32PPR            In magazzino: Out stock</p> <p><a href="#">RFQ</a></p>	 <p><b>62S11-H9-050S</b>            Produttori: Grayhill, Inc.            Descrizione: ROTARY ENCODER OPTICAL 32PPR            In magazzino: Out stock</p> <p><a href="#">RFQ</a></p>
 <p><b>62S11-L0-020C</b>            Produttori: Grayhill, Inc.            Descrizione: ROTARY ENCODER OPTICAL 32PPR            In magazzino: Out stock</p> <p><a href="#">RFQ</a></p>	 <p><b>62S11-L0-020CH</b>            Produttori: Grayhill, Inc.            Descrizione: ROTARY ENCODER OPTICAL 32PPR            In magazzino: Out stock</p> <p><a href="#">RFQ</a></p>
 <p><b>62S11-L0-040S</b>            Produttori: Grayhill, Inc.            Descrizione: ROTARY ENCODER OPT 32PPR 4" CBL            In magazzino: Out stock</p> <p><a href="#">RFQ</a></p>	 <p><b>62S11-H9-040S</b>            Produttori: Grayhill, Inc.            Descrizione: ROTARY ENCODER OPTICAL 32PPR            In magazzino: Out stock</p> <p><a href="#">RFQ</a></p>
 <p><b>62S11-H9-020S</b>            Produttori: Grayhill, Inc.            Descrizione: ROTARY ENCODER OPTICAL 32PPR            In magazzino: Out stock</p> <p><a href="#">RFQ</a></p>	 <p><b>62S11-H9-P</b>            Produttori: Grayhill, Inc.            Descrizione: ROTARY ENCODER OPTICAL 32PPR            In magazzino: Out stock</p> <p><a href="#">RFQ</a></p>
 <p><b>62S11-H9-PH</b>            Produttori: Grayhill, Inc.            Descrizione: ROTARY ENCODER OPTICAL 32PPR            In magazzino: Out stock</p> <p><a href="#">RFQ</a></p>	 <p><b>62S11-H9-025S</b>            Produttori: Grayhill, Inc.            Descrizione: ROTARY ENCODER OPTICAL 32PPR            In magazzino: Out stock</p> <p><a href="#">RFQ</a></p>
 <p><b>62S11-H9-060C</b>            Produttori: Grayhill, Inc.            Descrizione: ROTARY ENCODER OPTICAL 32PPR            In magazzino: Out stock</p> <p><a href="#">RFQ</a></p>	 <p><b>62S11-H9-040C</b>            Produttori: Grayhill, Inc.            Descrizione: ROTARY ENCODER OPTICAL 32PPR            In magazzino: Out stock</p> <p><a href="#">RFQ</a></p>