

**Panasonic**

Panasonic

## HC2E-H-AC48V-F

Numero di parti:

Manufacturer / Brand:

Descrizione di prodotto

Schede tecniche:

Status RoHS

Nave Da

Modu di Spedizioni

HC2E-H-AC48V-F

Panasonic

HC RELAY 2 FORM C 48VAC

 HC2E-H-AC48V-F.pdf

 Cumpite senza piombo / RoHS

Hong Kong

DHL/Fedex/TNT/UPS/EMS

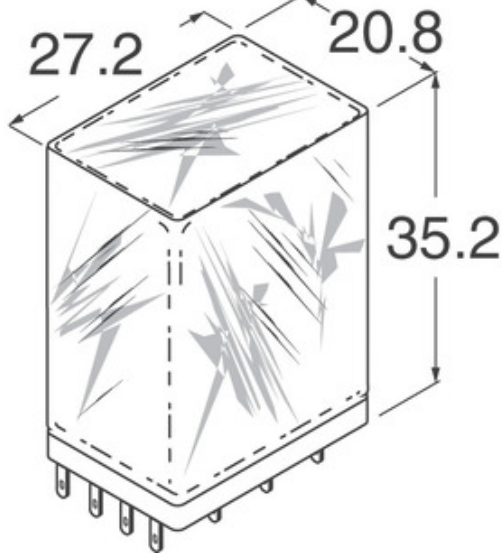

L'imaghjini pò esse ripresentazione. Vede e specificazioni per i dettagli di u produttu.

**RICHIESTA DI STIMA**









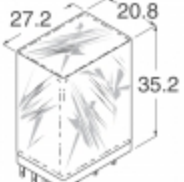

### Specificazioni di HC2E-H-AC48V-F

NUMERO DI PARTI	HC2E-H-AC48V-F
PRODUTTORE	Panasonic
DESCRIZIONE	HC RELAY 2 FORM C 48VAC
STATU SENZA PIOMBO / STATUS ROHS	Cumpite senza piombo / RoHS
SCHEDA TECNICA	 HC2E-H-AC48V-F.pdf
SERIE	*
LIVELLU DI SENSIBILITÀ À L'UMIDITÀ (MSL)	1 (Unlimited)
STATU SENZA PIOMBO / STATUS ROHS	Lead free / RoHS Compliant
DESCRIZIONE DETTAGLIATA	Relay Coil

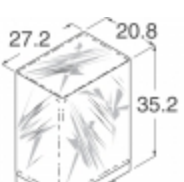
### Tags Tags

Panasonic HC2E-H-AC48V-F	Distributore HC2E-H-AC48V-F	Fornitore HC2E-H-AC48V-F
Prezzo HC2E-H-AC48V-F	HC2E-H-AC48V-F Pictures	Image HC2E-H-AC48V-F
Ficha Tecnica HC2E-H-AC48V-F PDF	HC2E-H-AC48V-F Scaricate a scheda tecnica	Ficha di dati HC2E-H-AC48V-F
Stock HC2E-H-AC48V-F	Cumprate HC2E-H-AC48V-F	Cumprate Panasonic HC2E-H-AC48V-F
Panasonic HC2E-H-AC48V-F	Fornitore Panasonic	Distributore Panasonic
Panasonic HC2E-H-AC48V-F	Panasonic - Consumer Division HC2E-H-AC48V-F	Panasonic - Consumer Electronics Corp. HC2E-H-AC48V-F
Panasonic Battery Group HC2E-H-AC48V-F	Panasonic Electric Works - ACS D HC2E-H-AC48V-F	Panasonic Electronic Components - Semiconductor Pr HC2E-H-AC48V-F
Panasonic - ATG HC2E-H-AC48V-F	Panasonic - BSG HC2E-H-AC48V-F	Panasonic - DTG HC2E-H-AC48V-F
Panasonic Electric Works HC2E-H-AC48V-F	Panasonic Electronic Components HC2E-H-AC48V-F	Panasonic Industrial Automation Sales HC2E-H-AC48V-F
Panasonic Semiconductor HC2E-H-AC48V-F		

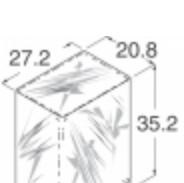
### Prodotti Relati

 <p><b>HC2E-H-AC6V-F</b>                  Produttori: Panasonic                  Descrizione: HC RELAY 2 FORM C 6VAC                  In magazzino: Out stock  <a href="#">RFQ</a></p>	 <p><b>HC2E-H-DC110V-F</b>                  Produttori: Panasonic                  Descrizione: HC RELAY                  In magazzino: Out stock  <a href="#">RFQ</a></p>
 <p><b>HC2E-H-AC6V</b>                  Produttori: Panasonic                  Descrizione: RELAY GENERAL PURPOSE DPDT 3A 6V                  In magazzino: Out stock  <a href="#">RFQ</a></p>	 <p><b>HC2E-H-AC24V</b>                  Produttori: Panasonic                  Descrizione: RELAY GEN PURPOSE DPDT 3A 24V                  In magazzino: Out stock  <a href="#">RFQ</a></p>
 <p><b>HC2E-H-AC200V-F</b>                  Produttori: Panasonic                  Descrizione: RELAY GEN PURP DPDT 200VAC                  In magazzino: Out stock  <a href="#">RFQ</a></p>	 <p><b>HC2E-H-AC24V-F</b>                  Produttori: Panasonic                  Descrizione: HC RELAY 2 FORM C 24VAC                  In magazzino: Out stock  <a href="#">RFQ</a></p>
 <p><b>HC2E-H-DC100V-F</b>                  Produttori: Panasonic                  Descrizione: RELAY GEN PURP DPDT 100VDC                  In magazzino: Out stock  <a href="#">RFQ</a></p>	 <p><b>HC2E-H-DC12V</b>                  Produttori: Panasonic                  Descrizione: RELAY GEN PURPOSE DPDT 3A 12V                  In magazzino: Out stock  <a href="#">RFQ</a></p>
 <p><b>HC2E-H-DC110V</b>                  Produttori: Panasonic                  Descrizione: RELAY GEN PURPOSE DPDT 3A 110V                  In magazzino: Out stock  <a href="#">RFQ</a></p>	 <p><b>HC2E-H-AC240V-F</b>                  Produttori: Panasonic                  Descrizione: HC RELAY 2 FORM C 240VAC                  In magazzino: Out stock  <a href="#">RFQ</a></p>
 <p><b>HC2E-H-AC240V</b>                  Produttori: Panasonic                  Descrizione: RELAY GEN PURPOSE DPDT 3A 240V                  In magazzino: Out stock  <a href="#">RFQ</a></p>	 <p><b>HC2E-H-AC48V</b>                  Produttori: Panasonic                  Descrizione: RELAY GEN PURPOSE DPDT 3A 48V                  In magazzino: Out stock  <a href="#">RFQ</a></p>